



*Submersible Sewage Pumps*  
**Vortex Impeller**

**U/UZ**





# Featuring a vortex impeller recessed in the widely opened pump casing interior, the U and UZ pumps can handle sewage with large solids without clogging or winding.

## Cable Entry

Every cable has an anti-wicking block at the cable entry section on the pump. This mechanism is such that a part of each conductor is stripped back and the part is sealed by molded rubber or epoxy potting which has flowed in between each strand of the conductor.



This unique feature prevents wicking along the strand of the conductor itself.

## Mechanical Seal

The mechanical seal with two seal faces containing silicon carbide (SiC) is equipped with the oil chamber. The advantages of the seal are two-fold, it eliminates spring failure caused by corrosion, abrasion or fouling which prevents the seal faces from closing properly, and prevents loss of cooling to the bottom seal faces during run-dry conditions which causes the bottom seal to fail.

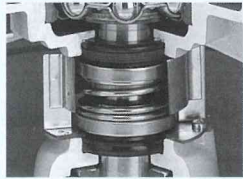

## Oil Lifter (Pat. Pending)

The Oil Lifter was developed as a lubricating device for the mechanical seal. Utilizing the centrifugal force of the shaft seal, the Oil Lifter forcibly supplies lubricating oil to the mechanical seal and continues to supply the oil to the upper seal faces even if lubricant falls below the rated volume. This amazingly simple device is not only reliably lubricates and cools down, but also retains the stable shaft seal effect and extends the inspection term.

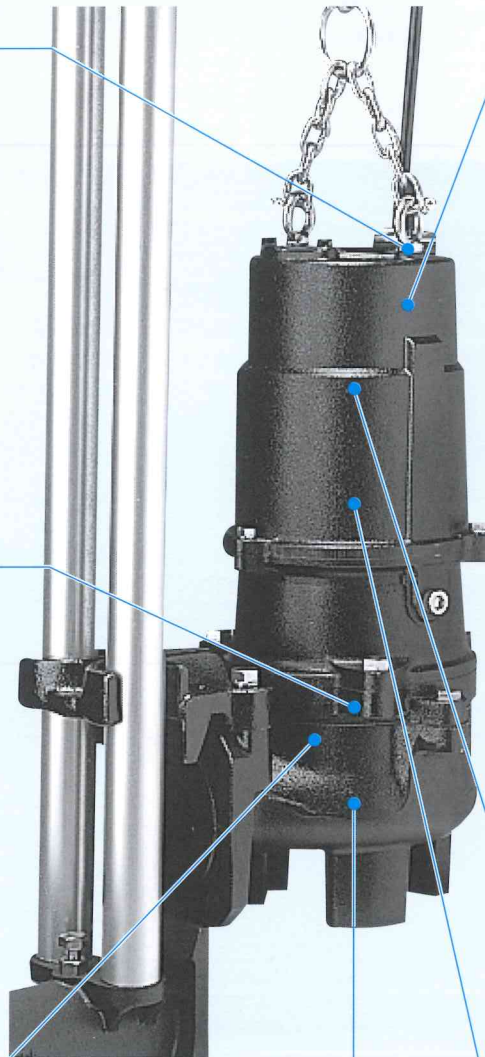
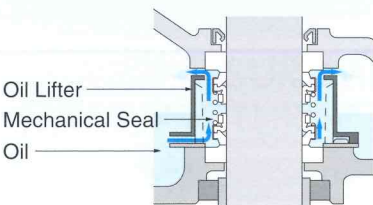

## Motor Protector

Each pump up to 7.5kW as standard has a built in auto-cut, self-resetting Circle Thermal Protector (CTP). Integrated in the motor housing, the CTP directly cuts the motor circuit if excessive heat builds up or an overcurrent caused by an electrical or mechanical failure occurs.

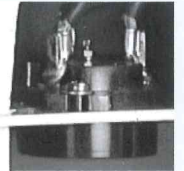

A Miniature Thermal Protector (MTP) is embedded in each winding of the motor. These MTPs are connected in series, and their wires are led out of the motor. Should the winding temperature rise to the actuating temperature, the bimetal strip opens to cause the control panel to shut the power supply.

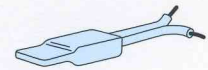

## Motor

The motor is a dry-type, squirrel cage induction motor, housed in a watertight casing, and conforms to insulation classes E or F. In each of these insulation classes, all standard pumps can be used in ambient temperatures up to 40°C.

## Impeller

The impeller is a vortex type. The rotation of the impeller produces a whirling, centrifugal action between the impeller and pump casing. Being coupled with a wide pump casing, even large solids and fibrous matters can be pumped out without obstruction.



## Shaft

The high-tensile stainless steel shaft used on all pumps is designed to have adequate strength for the transmission of the full load. It is supported by C3 type, high-quality, deep-groove ball bearings.

## MODEL NUMBER DESIGNATION

**100 UZ A 4 3.7 S**

Discharge bore in millimeters

Name of the series

Operation sub code

- None : None automatic operation
- A : Automatic operation
- W : Auto-alternation operation

Phase

- None : Three-phase
- S : Single-phase

Rated motor output in kilowatts

Number of poles of the motor

(This model does not exist.)



# GUIDE RAIL FITTING SYSTEM

The guide rail fitting system connects the pump to and from the piping easily just by lowering and hoisting the pump, allowing easy maintenance and inspection without the need to enter the sump.

Pump models used in combination with the guide rail fitting system can be identified by the prefix "TOS", "TS" and "TOK". Refer to standard specifications for availability and model numbers.

## TOS

The TOS is the standard guide rail fitting system made of cast-iron and is compatible with cast-iron pumps. Pumps having discharge bore from 50mm to 100mm are available for the TOS.



## TS

This compact guide rail fitting system is ideal for installing in prefabricated lift stations. Its discharge flange is compatible with major flange standards including ANSI 150lb, BS PN10 and DIN PN10. Pumps having a discharge bore from 50mm to 100mm are available for the TS.



## TOK

Made of high-quality resin, the TOK is designed for light-weight, small pumps. Rubber bellow attached to the guide hook are inverted to the duckfoot bend when the pump starts operating. This eliminates leakage at the seal even if a light-weight pump is used in combination with the TOK.

The TOK can be used with the U series pumps of 0.25kw to 0.75kw with maximum discharge bore of 50mm.



## AUTOMATIC MODEL

The automatic model has an integral control circuit and two float switches that operate at a low voltage. It operates automatically in response to the change in water levels. As it has a Circle Thermal Protector (CTP) integrated into the motor to protect the motor from overload or overheating, it is not required to provide an extra motor protection circuit in the starter panel.

This model can be identified by the suffix "A". Refer to the standard specifications for availability and model numbers.



## AUTO-ALTERNATION MODEL

The auto-alternation model is used along with an automatic model. The combinational use of these two pumps enables each pump to operate alternately without control panel.

The auto-alternation model has three floats and can be identified by the suffix "W". Refer to standard specifications for availability and model numbers. It is available in the same output range of the automatic pumps.

### How the Auto-alternation Model Works

● Operation is enabled by merely connecting the power supply.

#### Primary Operation

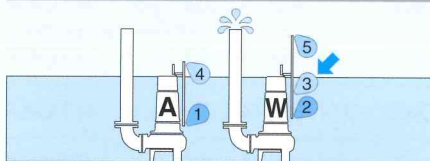

1 Float 3 operates, and pump W starts to discharge water.

#### Secondary Operation

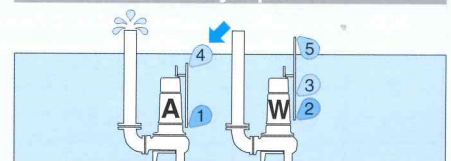

1 Start float 4 of pump A operates to start water discharge.

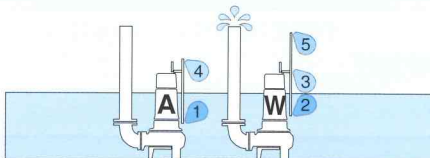

2 Water is discharged (water level falls).

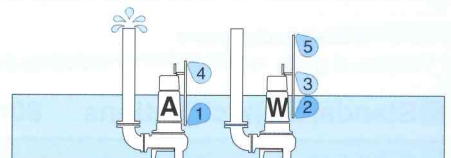

2 Water is discharged (water level falls).

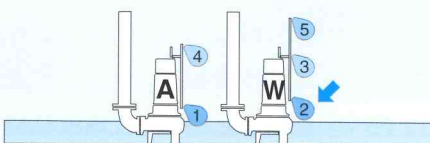

3 Stop float 2 of pump W operates to end water discharge. At this time, alternation start float 3 of pump W rests for one discharge operation.

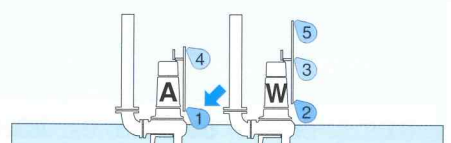

3 Stop float 1 of pump A operates to end water discharge. At the same time, start float 3 of pump W becomes ready for operation.

※ Primary operation and secondary operation are repeated alternately.

※ Both primary and secondary operations are performed simultaneously when water has risen to an abnormal level.

# U 40 · 50mm

## Performance Curves

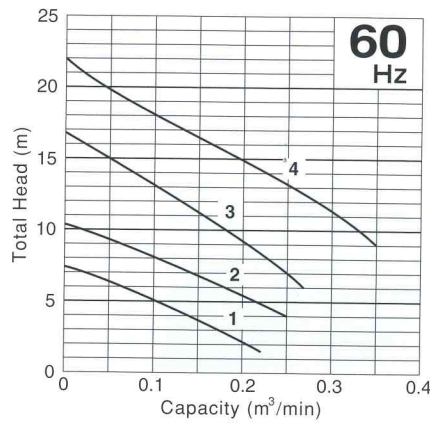
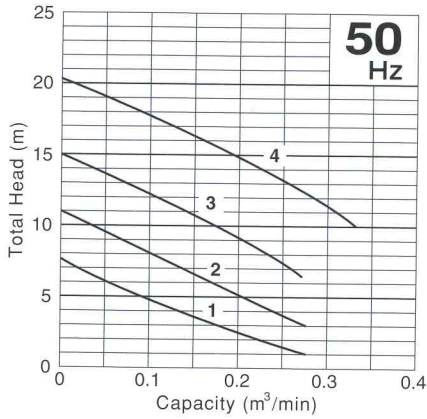

## Dimensions

Free Standing

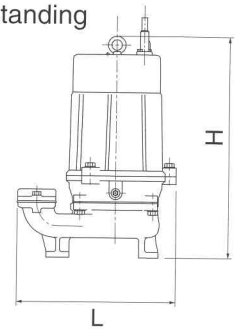

Guide Rail Fitting

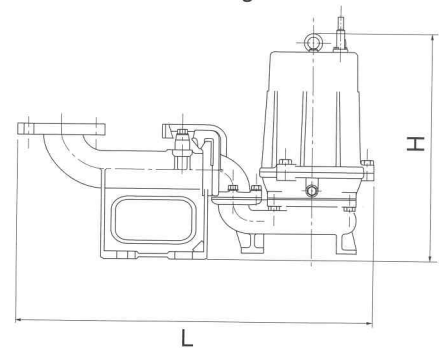

## Standard Specifications 40 · 50mm

Curve No.	Discharge Bore mm	Standard Model		Automatic Model		Auto-Alternation Model	
		Free Standing	Guide Rail Fitting	Free Standing	Guide Rail Fitting	Free Standing	Guide Rail Fitting
1	40	40U2.25S	(TOK)	40UA2.25S	(TOK)	40UW2.25S	(TOK)
	40	40U2.25	(TOK)	40UA2.25	(TOK)	40UW2.25	(TOK)
2	50	50U2.4S	(TOK)	50UA2.4S	(TOK)	50UW2.4S	(TOK)
	50	50U2.4	(TOK)	50UA2.4	(TOK)	50UW2.4	(TOK)
3	50	50U2.75	(TOK)	50UA2.75	(TOK)	50UW2.75	(TOK)
4	50	50U21.5	TOS50U21.5	50UA21.5	TOS50UA21.5	50UW21.5	TOS50UW21.5

\* All weights excluding cable  
Weights of guide rail fitting model excluding duckfoot bend

## Standard Specifications 80mm

Curve No.	Discharge Bore mm	Standard Model		Automatic Model		Auto-Alternation Model	
		Free Standing	Guide Rail Fitting	Free Standing	Guide Rail Fitting	Free Standing	Guide Rail Fitting
1	80	80U2.75	TOS80U2.75	80UA2.75	TOS80UA2.75	80UW2.75	TOS80UW2.75
2	80	80U21.5	TOS80U21.5	80UA21.5	TOS80UA21.5	80UW21.5	TOS80UW21.5
3	80	80U22.2	TOS80U22.2	80UA22.2	TOS80UA22.2	80UW22.2	TOS80UW22.2
4	80	80U23.7	TOS80U23.7	80UA23.7	TOS80UA23.7	80UW23.7	TOS80UW23.7

\*1 200~240V

\*2 All weights excluding cable

◆ Weights of guide rail fitting model excluding duckfoot bend



## Performance Curves

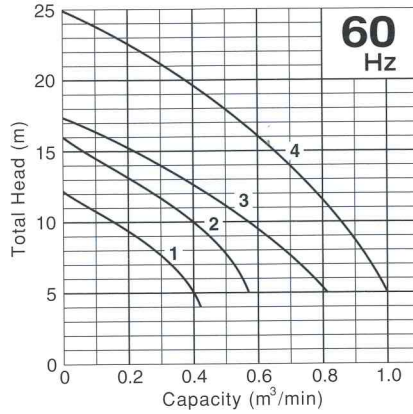
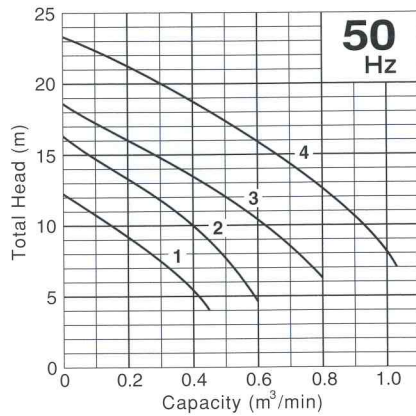

## Dimensions

Free Standing

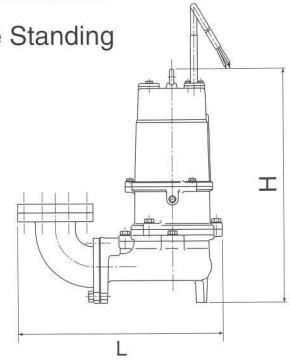

Guide Rail Fitting

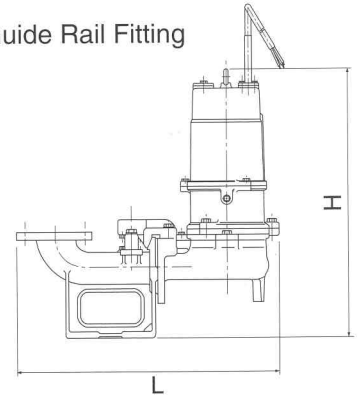

Motor Output kW	Phase	Speed (S.S.) 50Hz/60Hz min <sup>-1</sup>	Starting Method	Impeller Passage mm	Cable Length m	Cable Code	Dimensions L×H mm				Dry Weight * kgs			
							Standard Model		Auto & Auto-Alternation Model		Standard Model		Auto & Auto-Alternation Model	
							Free Standing	Guide Rail Fitting	Free Standing	Guide Rail Fitting	Free Standing	Guide Rail Fitting	Free Standing	Guide Rail Fitting
0.25	Single	3000/3600	Split-phase	35	5	a	241×383	—	241×433	—	14.0	—	14.5	—
0.25	Three	3000/3600	D.O.L.	35	6	A	241×383	—	241×433	—	13.5	—	14.5	—
0.4	Single	3000/3600	Capacitor	35	5	a	236×433	—	236×450	—	20.0	—	21.0	—
0.4	Three	3000/3600	D.O.L.	35	6	A	236×400	—	236×450	—	19.2	—	20.0	—
0.75	Three	3000/3600	D.O.L.	35	6	A	249×395	—	283×475	—	23.0	—	24.0	—
1.5	Three	3000/3600	D.O.L.	35	6	A	297×466	658×478	319×560	680×572	30.0	35.0	31.0	26.0

Motor Output kW	Phase	Speed (S.S.) 50Hz/60Hz min <sup>-1</sup>	Starting Method	Impeller Passage mm	Cable Length m	Cable Code	Dimensions L×H mm				Dry Weight *2 kgs			
							Standard Model		Auto & Auto-Alternation Model		Standard Model		Auto & Auto-Alternation Model	
							Free Standing	Guide Rail Fitting	Free Standing	Guide Rail Fitting	Free Standing	Guide Rail Fitting	Free Standing	Guide Rail Fitting
0.75	Three	3000/3600	D.O.L.	46	6	A	383×421	570×523	417×501	604×603	29.0	24.0	29.0	25.0
1.5	Three	3000/3600	D.O.L.	46	6	A	420×501	612×603	442×595	634×697	40.0	36.0	41.0	37.0
2.2	Three	3000/3600	D.O.L.	56	6	B	502×562	641×647	502×656	641×741	55.0	51.0	63.0	59.0
3.7	Three	3000/3600	D.O.L.	56	6	B(C*1)	502×565	641×650	502×629	641×714	59.0	58.0	70.0	69.0

# UZ 50 · 80mm

## ■ Dimensions

Free Standing

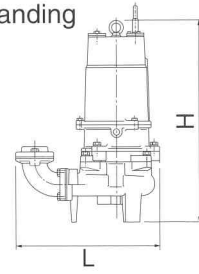

Guide Rail Fitting

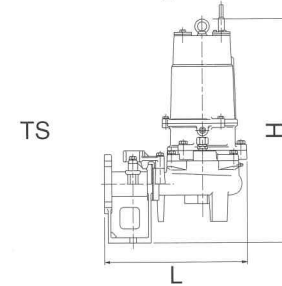
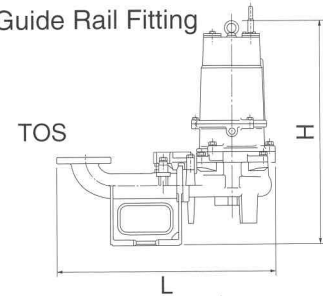

## ■ Performance Curves

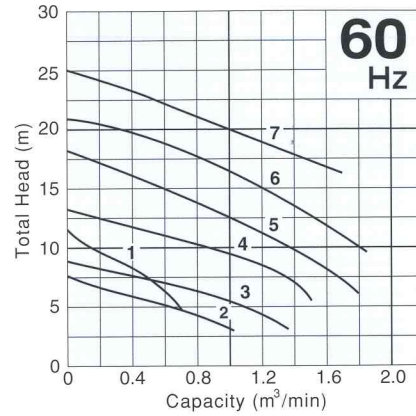
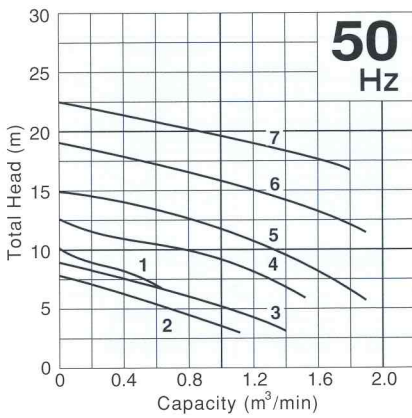

## ■ Standard Specifications 50 · 80mm

Curve No.	Discharge Bore mm	Standard Model			Automatic Model			Auto-Alternation Model		
		Free Standing	Guide Rail Fitting		Free Standing	Guide Rail Fitting		Free Standing	* Guide Rail Fitting	
			TOS	TS		TOS	TS		TOS	TS
1	50	50UZ41.5	TOS50UZ41.5	TS50UZ41.5	50UZA41.5	TOS50UZA41.5	TS50UZA41.5	50UZW41.5	TOS50UZW41.5	TS50UZW41.5
2	80	80UZ41.5	TOS80UZ41.5	TS80UZ41.5	80UZA41.5	TOS80UZA41.5	TS80UZA41.5	80UZW41.5	TOS80UZW41.5	TS80UZW41.5
3	80	80UZ42.2	TOS80UZ42.2	TS80UZ42.2	80UZA42.2	TOS80UZA42.2	TS80UZA42.2	80UZW42.2	TOS80UZW42.2	TS80UZW42.2
4	80	80UZ43.7	TOS80UZ43.7	TS80UZ43.7	80UZA43.7	TOS80UZA43.7	TS80UZA43.7	80UZW43.7	TOS80UZW43.7	TS80UZW43.7
5	80	80UZ45.5	TOS80UZ45.5	TS80UZ45.5	—	—	—	—	—	—
6	80	80UZ47.5	TOS80UZ47.5	TS80UZ47.5	—	—	—	—	—	—
7	80	80UZ411	TOS80UZ411	TS80UZ411	—	—	—	—	—	—

\*1 200~240V

\*2 All weights excluding cable  
Weights of guide rail fitting model excluding duckfoot bend

## ■ Standard Specifications 100mm

Curve No.	Discharge Bore mm	Standard Model			Automatic Model			Auto-Alternation Model		
		Free Standing	Guide Rail Fitting		Free Standing	Guide Rail Fitting		Free Standing	Guide Rail Fitting	
			TOS	TS		TOS	TS		TOS	TS
1	100	100UZ43.7	TOS100UZ43.7	TS100UZ43.7	100UZA43.7	TOS100UZA43.7	TS100UZA43.7	100UZW43.7	TOS100UZW43.7	TS100UZW43.7
2	100	100UZ45.5	TOS100UZ45.5	TS100UZ45.5	—	—	—	—	—	—
3	100	100UZ47.5	TOS100UZ47.5	TS100UZ47.5	—	—	—	—	—	—
4	100	100UZ411	TOS100UZ411	TS100UZ411	—	—	—	—	—	—

\*1 200~240V

\*2 All weights excluding cable  
Weights of guide rail fitting model excluding duckfoot bend



# 100mm

## Performance Curves

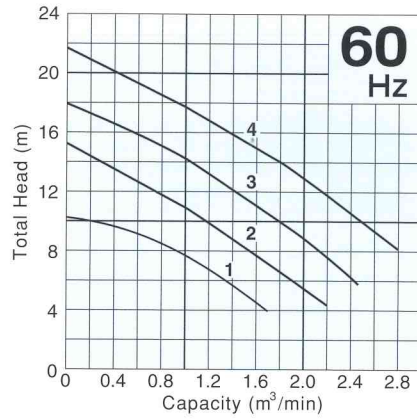
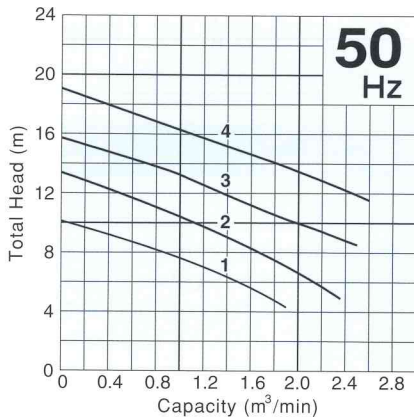

## Dimensions

Free Standing

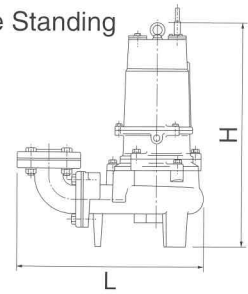

Guide Rail Fitting

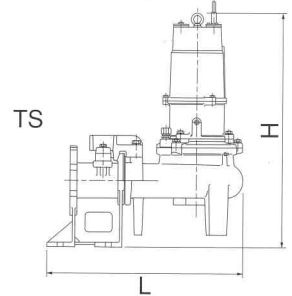
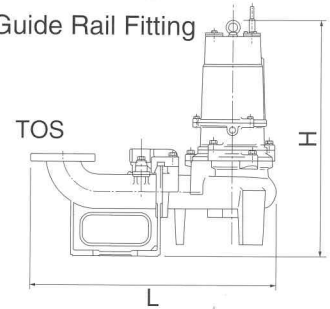

TS

Motor Output kW	Phase	Speed (S.S.) 50Hz/60Hz min <sup>-1</sup>	Starting Method	Impeller Passage mm	Cable Length m	Cable Code	Dimensions L×H mm						Dry Weight *2 kgs			
							Standard Model			Auto & Auto-Alternation Model			Standard Model		Auto & Auto-Alternation Model	
							Free Standing	Guide Rail Fitting		Free Standing	Guide Rail Fitting		Free Standing	Guide Rail Fitting	Free Standing	Guide Rail Fitting
								TOS	TS		TOS	TS				
1.5	Three	1500/1800	D.O.L.	50	6	A	405×566	621×626	398×626	405×683	621×743	398×743	52.0	50.0	58.0	56.0
1.5	Three	1500/1800	D.O.L.	80	6	A	531×637	705×670	552×670	531×754	705×787	552×787	66.0	56.0	73.0	63.0
2.2	Three	1500/1800	D.O.L.	80	6	B	531×637	705×670	552×670	531×754	705×787	552×787	66.0	57.0	73.0	64.0
3.7	Three	1500/1800	D.O.L.	80	6	B(C*1)	557×688	731×721	578×721	557×861	731×894	578×894	72.0	63.0	79.0	70.0
5.5	Three	1500/1800	D.O.L.	80	8	D	595×899	768×927	615×927	—	—	—	129.0	125.0	—	—
7.5	Three	1500/1800	D.O.L.	80	8	E	595×920	768×948	615×948	—	—	—	142.0	137.0	—	—
11	Three	1500/1800	Star-Delta	80	8	F	602×981	776×1107	623×1007	—	—	—	178.0	178.0	—	—

Motor Output kW	Phase	Speed (S.S.) 50Hz/60Hz min <sup>-1</sup>	Starting Method	Impeller Passage mm	Cable Length m	Cable Code	Dimensions L×H mm						Dry Weight *2 kgs			
							Standard Model			Auto & Auto-Alternation Model			Standard Model		Auto & Auto-Alternation Model	
							Free Standing	Guide Rail Fitting		Free Standing	Guide Rail Fitting		Free Standing	Guide Rail Fitting	Free Standing	Guide Rail Fitting
								TOS	TS		TOS	TS				
3.7	Three	1500/1800	D.O.L.	100	6	B(C*1)	627×737	846×777	651×777	627×910	846×950	651×950	79.0	70.0	86.0	77.0
5.5	Three	1500/1800	D.O.L.	100	8	D	652×939	871×974	676×974	—	—	—	145.0	134.0	—	—
7.5	Three	1500/1800	D.O.L.	100	8	E	652×960	871×995	676×995	—	—	—	159.0	148.0	—	—
11	Three	1500/1800	Star-Delta	100	8	F	660×1021	879×1054	684×1054	—	—	—	191.0	180.0	—	—

## CABTYRE CABLE CODE REFERENCE

### Single-Phase

Code	No. of Cables	Cores × mm <sup>2</sup>	Outer Dia. mm	Material
a	1	3 × 1.25	10.1	PVC

### Three-Phase

Code	No. of Cables	Cores × mm <sup>2</sup>	Outer Dia. mm	Material
A	1	4 × 1.25	11.1	PVC
B	1	4 × 2.0	11.8	
C	1	4 × 3.5	13.9	

Code	No. of Cables	Cores × mm <sup>2</sup>	Outer Dia. mm	Material
D	1	4 × 3.5	14.1	Chloroprene Rubber
E	1	4 × 5.5	16.8	
F	3	4 × 3.5	14.1	
		3 × 3.5	12.9	
		2 × 1.25	9.8	

## TSURUMI OPTIONS

### SPECIAL VERSION WITH GALVANIC CORROSION PROTECTION

In sea water, the effect of galvanic corrosion is more serious than that of ordinary corrosion. When two kinds of metals are dipped into an electrolytic liquid, a battery phenomenon occurs due to the difference in the electric potential of the two metals. In this case, the metal having the higher potential corrodes first. As an option, Tsurumi can supply pumps with parts made of higher electric potential metal as the sacrificial anode.

### SPECIAL VERSION FOR HIGHER TEMPERATURE LIQUID

Standard pumps are designed for continuous running at the maximum ambient temperature of 40°C. In addition to these, Tsurumi can provide pumps for operation at higher liquid temperatures upon request. Refitting for operation at higher temperatures involves modification of not only the insulation of motor windings but also several components.

Two high-temperature operating models are available - the Rank 60 for operation in liquids up to 60°C and the Rank 90 for operation in liquids up to 90°C. Consult your dealer for more details. (These special versions are not available for some pump models.)

### DRY PIT VERSION

The advantage of dry pit model is that it will not be damaged by flooding, as it is constructed with a submersible pump. Tsurumi can provide the dry pit model as option for the whole range of U/UZ series pumps. The water jacket covers whole part of the motor. It efficiently cools the motor for continuous operations.

### SPECIAL VERSION WITH NON-STANDARD MATERIALS

Tsurumi can also provide you with pumps with essential components such as the impeller, pump casing and the suction cover made of non-standard materials. Select from stainless-steel, chromium iron and bronze to suit your specific requirements. Consult your dealer for more details.

## SPECIAL ACCESSORIES

### FLOAT SWITCHES

Tsurumi offers two types of float switches (liquid level sensors). A micro-switch is incorporated in both types.

Model MC-2 is a heavy-duty type float switch with a shock absorber. Having equipped with a high grade micro switch, the MC-2 assures trouble-free operation in the liquid containing much suspended solids and floating scum. Either of the two contacts, normally-open or normally-close, can be selected as required.



Model RF-5 is an economy type float which can detect upper/lower-limit water levels with single float. The snap on-off action ensures stable operation in clean or waste water containing suspended solids or oil and fat.



We reserve the right to change the specifications and designs for improvement without prior notice.

**TSURUMI**  
**MANUFACTURING CO.,LTD.**

Your Dealer